

**Uniden®**

**WDECT**  
WIDEBAND DIGITAL

**WDECT3315**  
**WDECT3315 + 1**

**Series Owner's Manual**

**OWNER'S MANUAL**



## INSTALLATION & SAFETY

Choosing the best location for your phone.  
When choosing a location for your phone there are a number of appliances the phone should not be near, and areas you should avoid.

**AVOID -  
Television  
sets and other  
electronic  
appliances**

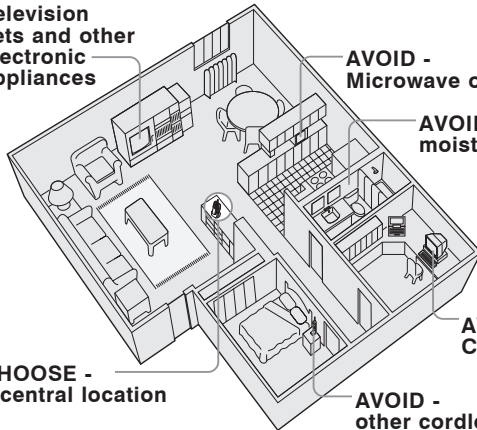

**CHOOSE -  
a central location**

**AVOID -  
Microwave ovens**

**AVOID -  
moisture**

**AVOID -  
Computers**

**AVOID -  
other cordless  
telephones**

AVOID -  
Moisture



Don't -  
overload the  
power outlet.

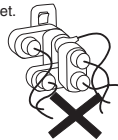

CHARGE -  
the new phone  
for 15 - 20 hrs.

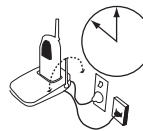

AVOID -  
multi power boards.



**Note:** Ringing will not be impaired by adding extra cordless handsets. For detailed installing method, please refer Set-Up Guide.

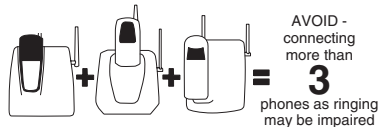

- This symbol indicates important operating and servicing instructions.

- The earcap of this telephone may attract and retain small metallic objects.

# CONTENTS

## INSTALLATION & SAFETY

### CONTENTS

#### GETTING STARTED

Controls and Functions

Welcome

Features

Terminology

Mounting the Base Unit on a Wall

Battery Maintenance

Installing the Beltclip

Headset Installation

Display and Icons

About the Menu Options

Setting up the Menu

#### BASICS

Making and Receiving Calls

Keypad Lock

Placing a Call on Hold

Redialing a Call

Adjusting the Handset Ringer,  
Earpiece and Speaker Volume

Mute Microphone

Tone Dialing Switch-Over (Australia Only)

Traveling Out-of-Range

Clarity Booster

Privacy Mode

Find Handset

Flash and Call Waiting

Using One Touch Voice Mail Access

#### PHONEBOOK

Phonebook

i

ii

1

1

2

3

3

4

5

6

7

7

8

11

18

18

19

19

20

21

22

22

22

23

23

24

24

25

25

26

26

Storing Phone Numbers, Names,  
Distinctive Rings, and Speed Dial

26

Steps for Entering Names and Special Characters

28

Viewing the Phonebook

30

Making Calls Using the Phonebook

31

Speed Dialing

31

Editing or Erasing a Stored Name,

Phone Number, Distinctive Ring, and Speed Dial

32

Chain Dialing

33

#### CALLER ID

34

Caller ID

34

Viewing the Caller ID List

35

Deleting a Caller ID Message

36

Using the Caller ID Message List

37

#### EXPANDING YOUR PHONE

38

Expanding your Phone

38

Register the Handset

39

Using Two Way Communication between the

Handsets Anywhere without the Base (Directlink)

40

Room Monitor

40

3-Way Conferencing

41

Intercom/Call Transfer Feature

41

Replacing the Base

42

#### ADDITIONAL INFORMATION

43

Changing the Digital Security Code

43

Note on Power Sources

44

#### TROUBLESHOOTING

45

#### INDEX

47

#### WARRANTY

48

## CONTROLS AND FUNCTIONS

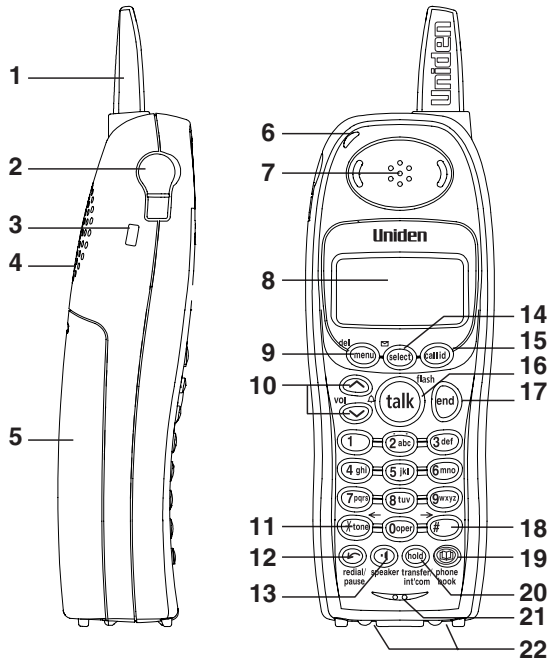

1. Handset Antenna
2. Headset Jack Cover
3. Beltclip Hole
4. Hands-Free Speaker
5. Handset Battery Compartment
6. New Message LED
7. Handset Earpiece
8. LCD Display
9. **menu** / **del** Key
10. **▲** / **vol** / **▲** / **▼** Key
  - a. ringer volume control
  - b. scroll keys for display screen
11. **\*** / **tone** / **←** Key
12. **↶** **redial/pause** Key
13. **🔊** **speaker** Key
14. **select** / **✉** Key
15. **call id** Key
16. **talk** / **flash** Key
17. **end** Key
18. **#** / **→** Key
19. **📖** **phonebook** Key
20. **hold** / **transfer/int'com** Key
21. Handset Microphone
22. Handset Charging Contacts

GETTING STARTED

## Main Base

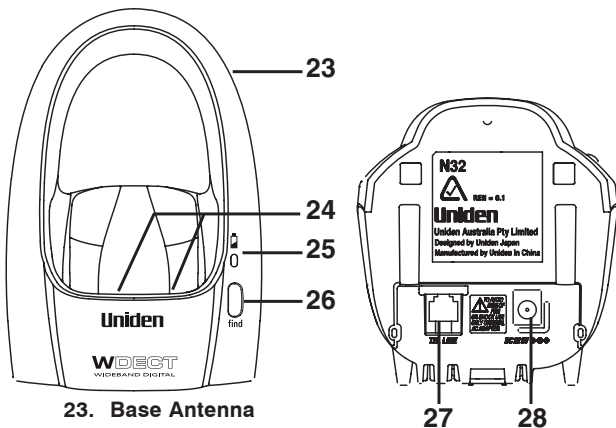

- 23. Base Antenna
- 24. Base Charging Contacts
- 25. charge LED
- 26. (find) Key
- 27. TEL LINE Jack
- 28. DC IN 9V Jack

## CHARGER BASE for WDECT3315+1 only

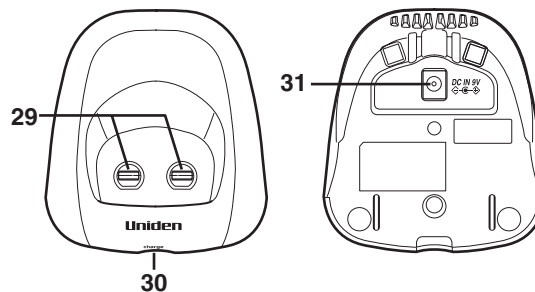

- 29. Charging Contacts
- 30. charge LED
- 31. DC IN 9V Jack

## WELCOME

Congratulations on your purchase of the Uniden Multi-Handset Cordless System telephone. This unit is different from conventional cordless telephones. When the base unit is connected to AC power and a telephone line, it can support up to 4 handsets. Using extra handsets, you can establish a 3-way conference call (2 handsets and an outside line), while two other handsets are making an intercom call. You can now place a fully featured cordless handset anywhere in your home or office where AC power is available to connect the handset chargers.

**Note:** The illustrations in this manual are intended as a guide and may differ from actual unit.

## FEATURES

Great features of this cordless phone include:

- Designed and Engineered in Japan
- Wide Band Digital Technology
- Multi (4) Handset Capable
- Digital Duplex Speakerphone on Handset

Advanced Alpha Display Caller ID Features:



- Alpha Memory Dialing
- POP ID - Caller Name Identification\*
- 20 Individual Caller Tone Allocation\*
- 100 Caller ID \* Memories with Phonebook
- 3 Line Backlit Full Dot Matrix LCD Display with Clock
- Maxi-Sound - Extra Loud Handset Volume Control
- Intercom/Announce Call Transfer
- Handset Conferencing (2 Handsets + Outside Call)
- Two-Way Communication between Handsets Anywhere without the Base
- And More!

\* Caller ID, POP ID and Individual Caller Tone Allocation (Distinctive Ring) features work only if you subscribe to the service provided by your local telephone company. There is usually a fee for this service.

# Range may vary depending on environmental and/or topographical conditions.

## TERMINOLOGY

Throughout this manual, terms such as Standby and Talk Mode are used. Below is the terminology explanation.

**Standby Mode** - The handset is not in use, is off the cradle, and /flash or  **speaker** has not been pressed. A dial tone is not present.

**Talk Mode** - The handset is not in the cradle and /flash or  **speaker** has been pressed enabling a dial tone. "Talk" appears on the display.

**DirectLink** - Two way communication between the handsets anywhere without the base.

## MOUNTING THE BASE UNIT ON A WALL

You can mount your base directly to the wall. Before doing this, consider the following:

- Avoid electrical cables, pipes, or other items behind the mounting location that could cause a hazard when inserting screws into the wall.
- Mount your phone within distance of a working phone jack.
- Make sure the wall material is capable of supporting the weight of the base and handset.
- Use screws with anchoring devices suitable for the wall material where the base unit will be placed.

1) Insert two mounting screws into the wall (with their appropriate anchoring device), 85mm apart. Allow about 3mm between the wall and screwheads for mounting the phone.

2) Plug the AC adapter into the **DC IN 9V** jack on the telephone and then into a Standard AC wall outlet.

3) Plug the telephone cord into the **TEL LINE** jack on the telephone and then into the telephone socket on the wall.

4) Align the mounting slots on the base with the mounting posts on the wall.

5) Then push in and down until the phone is firmly seated.

This phone also can be mounted on any standard telephone wall plate (for Australia).

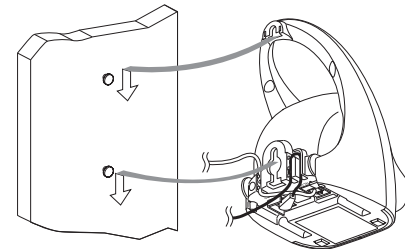
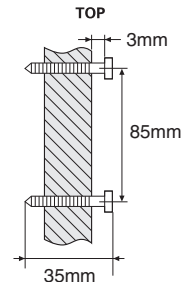



## BATTERY MAINTENANCE

### Battery use time (per charge)

Fully charged

- Up to 7 hours continuous use.
  - Up to 10 days when the handset is in the standby mode (up to 15 hours when in DirectLink mode)
- Recharge your phone on a regular basis by returning the handset to the charger after each phone call.

### Low battery alert

When the batteries are very low and need to be charged, the phone is programmed to eliminate functions in order to save power.

The batteries need to be charged when:

- The empty battery icon  appears.
- "Low Battery" appears in the display.

If the phone is in the standby mode, none of keys will operate. If you are on call, complete your conversation as quickly as possible, and return the handset to the cradle.

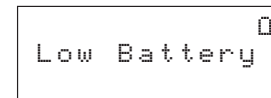

### Cleaning the battery charging contacts

To maintain a good charge, it is important to clean the charging contacts on the handset once a month. Use a dry cloth or pencil eraser to clean.

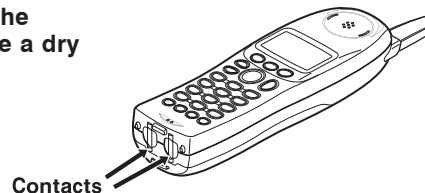

## Battery replacement and handling

When the operating time becomes short, even after a battery is recharged, please replace the battery. With normal usage, your battery should last about one year. Please contact your place of purchase or the Uniden Parts Department for a replacement battery.

### Caution

- Use only the specified Uniden battery pack (BT-446).
- Do not remove the batteries from the handset to charge them.
- Never throw the battery into a fire, disassemble them, or heat them.
- Do not remove or damage the battery casing.



To avoid the risk of personal injury or property damage from fire or electrical shock, only use the Uniden battery model and Uniden adapter model specifically designated for this product.

## INSTALLING THE BELTCLIP

### To attach the beltclip

Insert the beltclip into the holes on each side of the handset. Press down until it clicks into place.

### To remove the beltclip

Pull either side of the beltclip to release the tabs from the holes.



## HEADSET INSTALLATION

Your phone may be used with an optional headset, the Uniden HS910. To use this feature, insert the headset plug into the headset jack. Your phone is ready for hands-free conversations. Headset is available through Uniden authorized retailers.

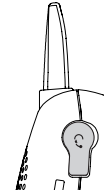

## DISPLAY AND ICONS

Example of the standby mode display

SUN 12:00A		Day of the week and time / battery icon
Handset #1		Handset ID and Banner
New: 5		Number of new Caller ID calls received / Ringer off icon (when the ringer is Off)

ICON	STATUS	DESCRIPTION
	<b>Standby/Talk</b>	Battery icon indicates the handset battery status. This icon cycles depending on the battery status (full, medium, low, and empty).
	<b>Standby</b>	Ringer off icon indicates that ringer is turned off.
	<b>Talk</b>	Mute icon appears when you mute the handset.
	<b>Talk</b>	Speaker icon appears when the handset speaker phone is used.
	<b>Talk</b>	Booster icon appears when the Clarity Booster feature is in use.
	<b>Talk</b>	Privacy icon appears when the Privacy Mode is turned on.



During Global Setup and System Reset, make sure your cordless phone is in standby mode (not in use), and all handsets are within range of the main base unit.

## ABOUT THE MENU OPTIONS

There are 5 main menu options, (**DirectLink Mode, Room Monitor, Handset Setup, Global Setup and System Reset**) and submenu options.

### Summary of the Main Menu and Submenu

#### **Two Way Communication between the Handsets Anywhere without the Base (DirectLink)**

DirectLink Mode allows a pair of handsets to work without the base unit, for direct handset-to-handset communication. Use them at sporting events or while shopping to stay in contact with family members or friends. You must set the two handsets to DirectLink Mode to utilize this feature.

#### **Room Monitor**

This feature only works if you have two or more handsets, allowing you to monitor sounds in another room (see page 12 for setup). One handset is placed in the desired room to monitor (acts as remote mic), and the other is placed near listener (remote speaker). This is useful for monitoring child activities.

## Handset Setup

The following submenu options must be set separately for each handset.

Submenu name	Description
<b>Edit Voice Mail</b>	Program or delete the voice mail access number (see page 12).
<b>Ringer Tones</b> (Default is Flicker)	Adjusting the ringer tone (tone your phone makes when ringing) (see page 13).
<b>Distinct. Ring</b> (Default is on)	Set the distinctive ring (see page 13). "Distinctive Ring" allows you to preset memory locations with a designated ring tone. When an incoming call is received and the Caller ID information matches the information in one of the memory locations, the distinctive ring that has been stored for that particular Caller will sound. If you have set multiple memory locations with distinctive rings, switching the setting to "Distinctive Off" will result in no distinctive ringing. All incoming calls will have a normal ring tone. Switching to "Distinctive On" will activate all programmed distinctive ring memory locations.
<b>AutoTalk</b> (Default is on)	Allows you to answer the phone without pressing (talk)/flash or (speaker) speaker. When the AutoTalk is set to on, simply remove the handset from the cradle and the phone automatically answers the call (see page 13).
<b>Anykey Answer</b> (Default is on)	Allows you to answer the phone without pressing (talk)/flash or (speaker) speaker. When the Anykey Answer is on, you can answer a call by pressing any number key, (*)/tone/←, or (#)/→ on the handset (see page 14).
<b>Banner (True Banner)</b>	Customize your handset(s) by giving it a banner name. The name will be displayed on the LCD screen during standby mode, Intercom, Transfer, Room Monitor and Copy Phonebook operation. The banner name will be displayed on the receiving handset as well (see page 14).
<b>Key Touch Tone</b> (Default is on)	Allows you to set your phone's key touch-tone to on or off (tone your keypad makes when keys are pressed) (see page 14).

## Global Setup

If you change one of the Global settings, you change the setting for all additional handsets. Only one handset can change Global settings at a time.

Submenu name	Description
<b>Name Tag (POP ID)</b>  (Default is on)	Display the stored name with the Caller ID telephone number, if the displayed Caller ID telephone number is exactly the same as a number stored in the phone book (see page 15).
<b>Insert 0</b> (New Zealand only)	Add "0" or "00" to the number, when you receive the Caller ID message (see page 15).
<b>Day &amp; time</b>	Set the day and time of your display (see page 15).
<b>Dial Mode</b>  (Australia only) (Default is tone)	Set the dial mode to tone or pulse (see page 16). Most phone systems use tone dialing, which send DTMF tone through phone line. The default is tone dialing. Depends on your dialing system, set the dial mode.
<b>Copy Phonebook</b>	Allow you to transfer the phonebook data stored in one handset to another handset (see page 16).

## System Reset

System Reset is used to clear the handset's ID from the main base unit, or the base ID from the handset.

Submenu name	Description
<b>Deregister HS</b>	Clear the handset ID from the base. Use this option, for example, when you change the digital security code (see page 17).
<b>Replacing Base</b>	Clear the base ID. Use this option, for example, if you wish to deregister the base to use the handset with another base of the WDECT3315 and WDECT3355 series (see page 17).

## SETTING UP THE MENU

### Entering the Menu

- 1) Press the **(menu)** /del key in standby mode.
- 2) Use **△/vol/▲** or **△/vol/▼** to move the pointer to a desired main menu (**DirectLink Mode, Room Monitor, Handset Setup, Global Setup, and System Reset**).
- 3) Press **(select)** /☑ to select the desired main menu.
- 4) Use **△/vol/▲** or **△/vol/▼** to select a desired submenu, and then press **(select)** /☑ to enter.  
In the submenu, use **△/vol/▲** or **△/vol/▼** to select an item. Press **(select)** /☑ to confirm your selection. For detailed instructions, see the following sections for the desired submenu.
- 5) To exit the menu, press **(end)** or return the handset to the cradle.

```
▶ DirectLink Mode
  Room Monitor
  Handset Setup
```

### DirectLink Mode

#### Entering the Two Way Communication between the Handsets Anywhere without the Base

- 1) Enter the DirectLink Mode menu (see “Entering the Menu” on page 11). To enter DirectLink mode press **(SELECT)** appears.
- 2) Press **(select)** /☑ to enter the DirectLink mode. You will hear a confirmation tone, and **DirectLink Mode Complete** appears.

```
To enter
DirectLink mode
press [SELECT]
```

To adjust ringer volume, press **△/vol/▲** or **△/vol/▼** to select one of three ringer volume (off, low, or high).

- 3) To return back to the normal mode, exit the DirectLink mode. Press **(menu)** /del, and then **(select)** /☑, or return the handset to the cradle. **DirectLink Mode Cancel** appears.

Tip

To back to the previous screen, press **(menu)** /del.



This is an example, if you have handset #1 and #2.



The Room/Baby monitor function is not a replacement for regularly checking the safety and security of children. The operating time is limited to the remaining charge of the battery and is not suitable for continuous overnight use.

## Room Monitor

### Using Room Monitor

- 1) Enter the Room Monitor menu (see “Entering the Menu” on page 11).

To Room Monitor appears.

- 2) Select the handset you want to monitor by using  $\Delta$  /vol/ $\Delta$  or  $\Delta$  /vol/ $\nabla$ .
- 3) Press  $\text{select}/\text{envelope}$ .

Room Monitor appears, and you hear sounds in the room where the handset is installed.

- 4) To finish the Room Monitor, press  $\text{end}$  or return the handset to the cradle.

```
To Room Monitor
▶ Handset #2
```

```
RoomMonitor ◀
↔ Handset #2
```

## Handset Setup

### Programming your Voice Mail Access Number

- 1) Enter the Handset Setup menu, and then the Edit Voice Mail submenu (see “Entering the Menu” on page 11). Edit V\_mail No. appears.

```
Edit V_mail No.
1234567890#
```

- 2) Enter your personal access number using the number keypad (**0-9**),  $\text{*/tone}/\leftarrow$ ,  $\text{#}/\rightarrow$ ,  $\text{menu}/\text{del}$ , or  $\text{redial}/\text{pause}$  (up to 20 digits).
- 3) Press  $\text{select}/\text{envelope}$ . You will hear a confirmation tone.

To delete the current Voice Mail Access Number, delete all numbers in step 2 using  $\text{menu}/\text{del}$  and  $\text{select}/\text{envelope}$ .



## Selecting a Ringer Tone

- 1) Enter the Handset Setup menu, and then the Ringer Tones submenu (see “Entering the Menu” on page 11).

There are 10 ringer tones or 10 Polyphonic Tones to choose from.

- Ringers [Flicker, Clatter, Soft Alert, Wake Up, Light Bug, Beep Boop, Tone Board, Chip Chop, Party Clap, Reminder]
- Polyphonic Tones [Beethoven’s Symphony #9 (Beethoven9), For Elise (Elise), We Wish You A Merry Christmas (Merry-Xmas), Home Sweet Home (Hm Swt Hm), Lorri Song #6 (Lorri Song), When the Irish Eyes Are Smiling (Irish Eyes), Aura Lee, Let Me Call You Sweet Heart (Sweetheart), Waltzing Matilda (W Matilda), Old MacDonald (Old MacDId)]

```
Ringer Tones
▶ Flicker
  Clatter
```

- 2) Press  $\Delta$  /vol/  $\Delta$  or  $\Delta$  /vol/  $\nabla$  to move the pointer. You will hear the ringer or Polyphonic Tone as you scroll through the options.
- 3) Press  $\text{\textcircled{select}}$  /  $\text{\textcircled{envelope}}$ . You will hear a confirmation tone.

## Distinctive Ringer Setup

- 1) Enter the Handset Setup menu, and then the Distinct. Ring submenu (see “Entering the Menu” on page 11).
- 2) Press  $\Delta$  /vol/  $\Delta$  or  $\Delta$  /vol/  $\nabla$  to select On or Off.
- 3) Press  $\text{\textcircled{select}}$  /  $\text{\textcircled{envelope}}$ . You will hear a confirmation tone.

```
Distinctive Ring
▶ On
  Off
```

## Setting the AutoTalk

- 1) Enter the Handset Setup menu, and then the Auto Talk submenu (see “Entering the Menu” on page 11).
- 2) Press  $\Delta$  /vol/  $\Delta$  or  $\Delta$  /vol/  $\nabla$  to select On or Off.
- 3) Press  $\text{\textcircled{select}}$  /  $\text{\textcircled{envelope}}$ . You will hear a confirmation tone.

```
Auto Talk
  On
▶ Off
```



**NOTE**

Distinctive ringing will only operate if you subscribe to the Caller ID service.

### Setting the Anykey Answer

- 1) Enter the Handset Setup menu, and then the Anykey Answer submenu (see “Entering the Menu” on page 11).
- 2) Press  $\Delta$  /vol/▲ or  $\Delta$  /vol/▼ to select On or Off.
- 3) Press (select)/✉. You will hear a confirmation tone.

```
Anykey Answer
On
▶Off
```

### Setting the True Banner

- 1) Enter the Handset Setup menu, and then the Banner submenu (see “Entering the Menu” on page 11).
- 2) Use the number keypad (0-9), (\*)/tone/←, (#)/→, or (menu) /del to enter or edit the name.
- 3) Press (select)/✉. You will hear a confirmation tone.

```
Banner
■----- #1
```

### Setting the Key Touch Tone

- 1) Enter the Handset Setup menu, and then the Key Touch Tone submenu (see “Entering the Menu” on page 11).
- 2) Press  $\Delta$  /vol/▲ or  $\Delta$  /vol/▼ to select On or Off.
- 3) Press (select)/✉. You will hear a confirmation tone.

```
Key Touch Tone
▶On
Off
```

## Global Setup

### Setting Name Tag (POP ID)

- 1) Enter the Global Setup menu, and then the Name Tag submenu (see “Entering the Menu” on page 11).
- 2) Press  $\Delta$  /vol/  $\Delta$  or  $\Delta$  /vol/  $\nabla$  to change the selection, On or Off.
- 3) Press  $\text{select}$  /  $\text{envelope}$ . You will hear a confirmation tone.

### Setting Insert Zero (New Zealand only)

- 1) Enter the Global Setup menu, and then the Insert 0 submenu (see “Entering the Menu” on page 11).
- 2) Press  $\Delta$  /vol/  $\Delta$  or  $\Delta$  /vol/  $\nabla$  to change the selection, On or Off.
- 3) Press  $\text{select}$  /  $\text{envelope}$ . You will hear a confirmation tone.

### Setting Day and Time

- 1) Enter the Global Setup menu, and then the Day & Time submenu (see “Entering the Menu” on page 11).
- 2) Press  $\Delta$  /vol/  $\Delta$  or  $\Delta$  /vol/  $\nabla$  to select the day of the week, and then press  $\text{select}$  /  $\text{envelope}$ .
- 3) Press  $\Delta$  /vol/  $\Delta$  or  $\Delta$  /vol/  $\nabla$  to set hour and then press  $\text{select}$  /  $\text{envelope}$ .
- 4) Press  $\Delta$  /vol/  $\Delta$  or  $\Delta$  /vol/  $\nabla$  to set minute and then press  $\text{select}$  /  $\text{envelope}$ .
- 5) Press  $\Delta$  /vol/  $\Delta$  or  $\Delta$  /vol/  $\nabla$  to choose AM or PM, and then press  $\text{select}$  /  $\text{envelope}$ . You will hear a confirmation tone.

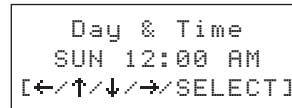

```
Day & Time
SUN 12:00 AM
[←/↑/↓/→/SELECT]
```



- When a Global setting is changed from one handset, this affects all registered handsets.

- For setting the Day and Time, the idle time-out is extended to 2 minutes.



- If you receive a call the transfer will be canceled.
- If an error occurs, the phonebook locations transferred before the error were stored in the receiving handset. `Unavailable` appears on the display.
- When the memory of the receiving handset is full, `Not enough memory in Receiving Handset` appears. You cannot transfer the phonebook location.

### Setting the Dial Mode (Australia only)

- 1) Enter the Global Setup menu, and then the Dial Mode submenu (see “Entering the Menu” on page 11).
- 2) Press  $\Delta$  /vol/  $\Delta$  or  $\Delta$  /vol/  $\nabla$  to change the select, `Tone` or `Pulse` (the initial setting is `Tone`).
- 3) Press `(select)` /  $\boxtimes$  . You will hear a confirmation tone.

```
Dial Mode
▶ Tone
Pulse
```

### Copy Phonebook

- 1) Enter the Global Setup menu, and then the Copy Phonebook submenu (see “Entering the Menu” on page 11).
- 2) Press  $\Delta$  /vol/  $\Delta$  or  $\Delta$  /vol/  $\nabla$  to choose `One Memory` or `All Memory`, and then press `(select)` /  $\boxtimes$  .  
If you choose `All Memory`, go to step 4.
- 3) Press  $\Delta$  /vol/  $\Delta$  or  $\Delta$  /vol/  $\nabla$  , or the number keypad **(0-9)** to select the phonebook location you want to export, and then press `(select)` /  $\boxtimes$  .
- 4) Press  $\Delta$  /vol/  $\Delta$  or  $\Delta$  /vol/  $\nabla$  to select the handset to which you want transfer the phonebook locations, and then press `(select)` /  $\boxtimes$  .

```
Copy Phonebook
▶ One Memory
All Memory :xxx
```

If you choose `All Memory` in the step 2, `Are you sure?` appears. Press  $\Delta$  /vol/  $\Delta$  or  $\Delta$  /vol/  $\nabla$  to select `Yes`, and then press `(select)` /  $\boxtimes$  .

The phonebook locations will be transferred to the handset. On the receiving handset, `Receiving` and the handset name appear. When the transfer complete, `Done!` appears on the handset.

## System Reset

### De-register the Handset

- 1) Enter the System Reset menu, and then the Deregister HS submenu (see “Entering the Menu” on page 11).
- 2) Press  $\Delta$  /vol/  $\Delta$  or  $\Delta$  /vol/  $\nabla$  to select the handset ID to be de-registered from the list, and then press (select) /  $\nabla$ . Deregister HS? appears.
- 3) Press  $\Delta$  /vol/  $\Delta$  or  $\Delta$  /vol/  $\nabla$  to select Yes.
- 4) Press (select) /  $\nabla$ . You will hear a confirmation tone. When de-registration is complete, Deregistration Complete appears.
- 5) After de-registering the handset, move to “Replacing the Base Setting” below.

```
Which Handset?
▶Handset    #1
  Handset    #2
```

```
Deregister HS?
  Yes
▶No
```

### Replacing the Base Setting

- 1) Enter the System Reset menu, and then the Replacing Base submenu (see “Entering the Menu” on page 11). Replace base? appears.
- 2) Press  $\Delta$  /vol/  $\Delta$  or  $\Delta$  /vol/  $\nabla$  to select Yes.
- 3) Press (select) /  $\nabla$ . You will hear a confirmation tone. The base information will be deleted. When replacing the base is complete, Place handset on main base to register appears, register the handset to the new base (see page 39).

```
Replace base?
  Yes
▶No
```



Make sure to perform the Replacing Base after de-register the handset.













- To set Autotalk, see page 13 or to set Anykey Answer see page 14.
- The handset microphone is located at the bottom of the handset (see “Controls and Functions” on page 1). Position yourself as near to the handset as possible and speak clearly.
- If the line is in use by another handset(s), Line in Use appears in the display of all registered handset’s display, that are not in use.

## MAKING AND RECEIVING CALLS

This handset has a built-in speakerphone that allows you to have a hands-free conversation. This feature allows you to communicate easily while performing other tasks, such as cooking.  appears during hands-free conversations.

You can easily switch a call from normal conversation to hands-free conversation.

To switch a call, press  **speaker** during the call.

	From the Handset	
	Normal conversation	Hands-free conversation
<b>To answer a call</b>	<b>Handset On the Cradle</b> Pick up the handset (AutoTalk) or pick up the handset and press  /flash .  <b>Handset Off the Cradle</b> Press any number key,  /tone/← , or  /→ (Any Key Answer), or press  /flash .	<b>Handset Off the Cradle</b> Press  speaker.
<b>To make a call</b>	<b>Handset Off the Cradle</b> 1) Press  /flash . 2) Listen for the dial tone. 3) Dial the number. OR Dial the number, and then press  /flash .	<b>Handset Off the Cradle</b> 1) Press  speaker. 2) Listen for the dial tone. 3) Dial the number. OR Dial the number, and then press  speaker.
<b>To hang up</b>	Press  , or return the handset to the cradle (AutoStandby).	
<b>To enter a pause within the dialing sequence</b>	When you dial the number, press  redial/pause. “P” appears in the display, which represents a pause.	

## KEYPAD LOCK

The Keypad Lock prevents user from pressing the keypad accidentally. You can still answer calls, and receive page and phonebook locations, and the keypad lock is reactivated after the operation.

### To lock the keypad

Press and hold **(\*)/tone/←** until you hear a confirmation tone. Keypad Locked appears.

If anykey is pressed when keypad is locked,  
To unlock keypad press & hold \* key appears.

### To unlock the keypad

Press and hold **(\*)/tone/←** again. Keypad Unlocked appears.

## PLACING A CALL ON HOLD

- 1) During a call, press **(hold) /transfer/int'com**.  
The call will be put on hold.

After 10 seconds of pressing **(hold) /transfer/int'com** or by pressing the **(end)** key, the handset display screen will read, Line On Hold.

- 2) To talk to the caller, press **(talk)/flash** or **(M)** **speaker** on a handset. The phone will return back to the call.

```
Hold, to transfer
▶ Handset #2
Handset #3
```

```
SUN 12:00A
Handset #1
Line On Hold
```



Emergency calls to “000” or “111” will not function when keypad is locked.



You can hold a call for 5 minutes, when 5 minutes has passed, the call is disconnected and the phone returns to standby mode.



- If the number exceeds 32 digits, only the first 32 digits are retained in redial memory.
- If the redial memory is empty, you will hear a beep.

## REDIALING A CALL

The last three phone numbers dialed can be quickly redialed.

### Redialing from Standby Mode

- 1) Press **redial/pause** in standby mode.
- 2) Press **redial/pause** again. Each press of **redial/pause** will display one of the last three numbers dialed.
- 3) Press **talk/flash** or **speaker**. The selected number is dialed.
- 4) To hang up, press **end**.

### Redialing from Talk Mode

- 1) Press **talk/flash** or **speaker**.
- 2) Press **redial/pause**. The last number dialed will be displayed and dialed. To hang up, press **end**.

### Deleting a Redial Record

- 1) Press **redial/pause** in standby mode.
- 2) Press **redial/pause** repeatedly to display the number to be deleted.
- 3) Press **menu/del**.
- 4) Press **/vol/▲** or **/vol/▼** to choose Yes.
- 5) Press **select/✉**. The dialed number is deleted.

### Storing a Redial Record

- 1) Press **redial/pause** in standby mode.
- 2) Press **redial/pause** repeatedly to display the number to be stored.
- 3) Press **select/✉**. Store/Edit Name appears.
- 4) To complete the setting, follow the steps 3-8 in "Storing Phone Numbers, Names, Distinctive Rings, and Speed dial" on page 26-27.

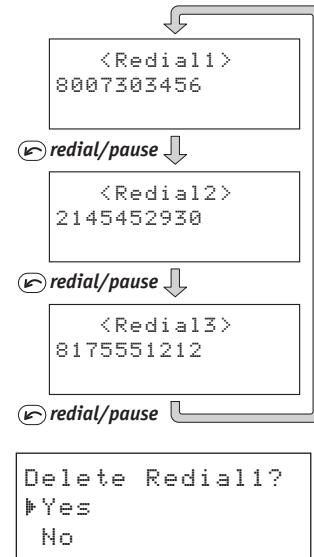



## ADJUSTING THE HANDSET RINGER, EARPIECE AND SPEAKER VOLUME

### Handset ringer volume

Press the volume up key or volume down key (labeled as  $\Delta$  /vol/▲ or  $\Delta$  /vol/▼) in standby mode to select one of three ringer volume (off, low, or high).

### Earpiece and speaker volume

Pressing the volume up key or volume down key (labeled as  $\Delta$  /vol/▲ or  $\Delta$  /vol/▼ key) during a call will change the earpiece or speaker and speaker volume of the handset. This setting will remain in effect after the telephone call has ended.



When you press volume up key ( $\Delta$  /vol/▲) in the maximum volume level or volume down key ( $\Delta$  /vol/▼) in the lowest volume level, an error tone sounds.

### Ringer Mute

You can temporarily mute the incoming ring. When the handset is off the cradle and the phone is ringing, press **end** . The incoming ring will return to the previous setting starting with the next incoming call.

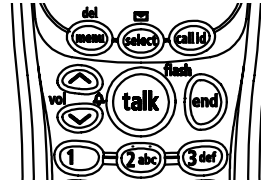

Standby Mode  
- The handset is not in use and **talk** / **flash** has not been pressed.



- The tone feature only applies when the dial mode is set to pulse.
- This special number can be stored in a memory location. This is referred to as Chain Dialing (see page 33)

## MUTE MICROPHONE

You can temporarily turn off the microphone so that the person you are talking with cannot hear you.

- 1) Press **menu** / **del** during talk mode (while phone is in use).
- 2) Press **▲** / **vol** / **▲** or **▲** / **vol** / **▼** to move the pointer to **Mute** and then **select** / **✉**. **Mute On** and **🔇** appear in the display. To cancel muting, repeat above step again when **Mute** is set to on, **Mute Off** appears.

## TONE DIALING SWITCH-OVER (AUSTRALIA ONLY)

Some telephone companies use equipment that requires pulse dialing (sometimes referred to as rotary dialing). If you need to enter tone dialing digits, you can switch-over to tone dialing during the call. This feature is useful when you need tone dialing to use automated systems, for example, entering your bank account number after you have called your bank.

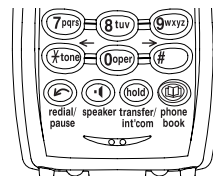

Initially make your call with the pulse dialing mode. Once your call connects, press **\* / tone** / **←**. Enter the desired number. These digits will be sent as tone dialing. Once the call ends, the tone mode is canceled and pulse dialing mode resumes.

## TRAVELING OUT-OF-RANGE

During a call, as you begin to move your handset too far from your base unit, noise may increase. If you pass the range limits of the base unit, you will hear a beep and see **Out of Range** on the display, and then the handset returns to standby mode. You may return to the call if you move your handset within the range limits of the base and press **talk** / **flash** or **🔊** **speaker** within 30 seconds.

## CLARITY BOOSTER

If you encounter interference while using your phone, you can manually improve the sound by setting the Clarity Booster to on. **This works only when the phone is in use.**

- 1) Press **(menu)** / **del** during talk time (while phone is in use).
- 2) Press **▲** / **vol** / **(▲)** or **▲** / **vol** / **(▼)** to move the pointer to **Clarity Boost**, and then **(select)** / **(☑)**.

**Boost On** and **B** appear in the display.

To turn Off the Clarity Booster, repeat above step again when the Clarity Booster is on, **Boost Off** appears.

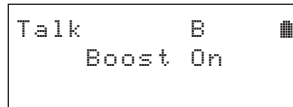

## PRIVACY MODE

Privacy Mode allows you privacy, and guarantee of no interruption from other registered handsets. **This works only when the phone is in use.**

- 1) Press **(menu)** / **del** during talk time (while phone is in use).
- 2) Press **▲** / **vol** / **(▲)** or **▲** / **vol** / **(▼)** to move the pointer to **Privacy Mode**, and then **(select)** / **(☑)**.

**Privacy Mode On** and **B** appear in the display.

To exit the Privacy Mode, repeat above step again when the Privacy Mode is on.

**Privacy Mode Off** appears.

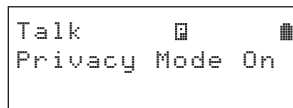

- Normally, the talk time duration is 7 hours, however, when the Clarity Booster is On, the talk time duration will be up to 5 hours with fully charged batteries.
- Clarity booster automatically turns off after each call.



If the battery pack is completely drained, the handset will not beep when paging.

## FIND HANDSET

To locate the handset, press **(find)** on the base when the base is in standby mode. All registered handsets beeps for 60 seconds, and "Paging" appears on the handset display. To cancel paging, press any key on the handset or **(find)** on the base.

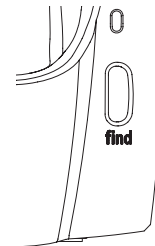

## FLASH AND CALL WAITING

If you have Call Waiting service and a call waiting tone sounds during a call:

**AUSTRALIA:**

Press **(talk) / flash**, then **2** to switch between callers.

**NEW ZEALAND:**

Press **(talk) / flash** to switch between callers.

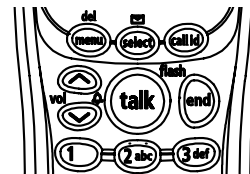

## USING ONE TOUCH VOICE MAIL ACCESS

If you subscribe to voice mail service, you can use your phone to access your voice mailbox. The new message LED flashes whenever you have messages waiting in your voice mailbox. Just program the handset with your access number, and you can get your messages at the touch of a button on the handset. (The voice mail service provider will supply you with the access number. This number may be simply a phone number. Refer to the provider's literature).

- **To program or delete your Voice Mail Access Number, See page 12.**

### Dialing your Voice Mail Service

Once you've programmed your personal access number, you can dial your mailbox with the touch of a button. When you have messages, simply pick up the handset and press **(select)/☐**. If you have not entered the access number or it has been deleted, when you press the **(select)/☐**, *No Number Stored To store number press [MENU]* appears and you will hear a beep. The phone returns to standby mode.

### Voice Mail Access

The new message LED on the handset is designed to work with your voice mail service provided by your local telephone company. The LED flashes when you have new incoming messages in the voice mail service. You may need to occasionally reset the indicators if they remain on after you've retrieved your messages. To reset the indicators, when the phone is in standby mode press and hold **(find)** on the base until the paging sound stops (about 5 seconds).



- You must subscribe to voice mail service from your telephone company in order to use this feature. The voice mail service company will provide you with the access number.

- Voice Mail Access Numbers :  
Australia  
Message Bank :  
125101  
Home Messages:  
101  
New Zealand  
Call Minder :  
083210



- Your phone has 100 memory locations for Caller ID messages or stored Phonebook numbers.
- Selecting a speed dial location where a number is already stored releases the old number's speed dial setting. The new number will be stored in the speed dial location.
- When the memory is full, you will hear a beep and Memory Full appears. You cannot store names and numbers.
- The pause key counts as one digit. Pressing **redial/pause** more than once increases the length of the pause between numbers. Each pause represents a 2 second pause.

## PHONEBOOK

The Phonebook allows you to dial a number using just a few key presses. Your phone stores names/numbers in the phonebook memory location, and you can search names in alphabetical order. You have a total of 100 locations that can be used for the phonebook (including the speed dials) and Caller ID messages.

## STORING PHONE NUMBERS, NAMES, DISTINCTIVE RINGS, AND SPEED DIAL

- 1) When the phone is in standby mode, press **phonebook**.  
The handset displays the following items:  
(1st line) The number of the phonebook locations used (2nd line) How to search (press the number keypad, **/vol/** or **/vol/**)  
(3rd line) How to enter the storing operation (press the **select/** key)
- 2) Press **select/**, Store/Edit Name appears.
- 3) Enter the name (up to 16 characters) by using the number keypad (see the "Steps for Entering Names and Special Characters" on page 28).  
If a name is not required, go to step 4. <No Name> will be used as the name.
- 4) Press **select/** to store the name, Store/Edit No. appears.
- 5) Press the number keypad to enter the phone number (up to 20 digits), press **select/** to store the number.

```
Phonebook :100
Search [A-Z/↑/↓]
Store [SELECT]
```

```
Store/Edit Name
Movies
```

```
Store/Edit No.
8007303456
```

- 6) Distinctive Ring appears. Press  $\Delta$  /vol/  $\Delta$  or  $\Delta$  /vol/  $\nabla$  to move the pointer to one of the Distinctive Ring options, and then press (select)/ $\boxtimes$ .



If you choose not to store a Distinctive Ring, simply select the "No Selectn" option.

```
Distinctive Ring
▶No Selectn
Flicker
```

- 7) Speed Dial appears. Press  $\Delta$  /vol/  $\Delta$  or  $\Delta$  /vol/  $\nabla$  to move the pointer to select the Speed dial location (10 locations: SPD1-SPD0).



If you choose not to store the name/number as a Speed Dial, simply select the "No Selectn" option.

```
Speed Dial
▶No Selectn
SPD1:<Empty>
```

- 8) Press (select)/ $\boxtimes$ . You will hear a confirmation tone, and Done! appears in the display.

```
Movies
0295979035
♪Beethoven9/SPD1
```



Distinctive ringing will only operate if you subscribe to the Caller ID service.

## STEPS FOR ENTERING NAMES AND SPECIAL CHARACTERS

Refer to the letters on the number keys to select the desired characters. With each press of a number key (**0**-**9**), the displayed character appears in the following order:

upper case letters first, lower case letters next and finally the number corresponding to the key.

keys	Number of times key is pressed								
	1	2	3	4	5	6	7	8	9
1	1								
2 abc	A	B	C	a	b	c	2		
3 def	D	E	F	d	e	f	3		
4 ghi	G	H	I	g	h	i	4		
5 jkl	J	K	L	j	k	l	5		
6 mno	M	N	O	m	n	o	6		
7 pqrs	P	Q	R	S	P	q	r	s	7
8 tuv	T	U	V	t	u	v	8		
9 wxyz	W	X	Y	Z	w	x	y	z	9
0 oper	&	<	>	<	>	/	(blank)	-	_
	.	,	:	?	!	@	'	"	*
	#	0							



### If you make a mistake while entering a name

Use  $\text{(*)/tone/}$ ← or  $\text{(*)/}$ → to move the cursor to the incorrect character.

Press  $\text{(menu) /del}$  to erase the wrong character and then enter the correct character.

To delete all characters, press and hold  $\text{(menu) /del}$ .

For example, to enter **Movies**:

- 1) When the phone is in standby mode, press  $\text{(☰) phonebook}$ .
- 2) Press  $\text{(select) /}$ ✉, Store/Edit Name appears.
- 3) Press **6** once, and then press  $\text{(*)/}$ → to move the cursor to the right.
- 4) Press **6** six times.
- 5) Press **8** six times.
- 6) Press **4** six times.
- 7) Press **3** five times.
- 8) Press **7** eight times.
- 9) When finished, press  $\text{(select) /}$ ✉.

To continue to store the telephone number, proceed to step 5 on page 26.

**Copy Phonebook:** To copy the phonebook entries to another handset please refer to page 16.



If the next character uses the same number key, you must press  $\text{(*)/}$ → to move the cursor over. Otherwise the next time you press the number key, it changes the character that was previously set.





## VIEWING THE PHONEBOOK

Your phone stores names/numbers in the phonebook memory locations, and you can search names in alphabetical order. You can view the phonebook even while the phone is in use.



- 1) Press  **phonebook**.



If you recall the phonebook during a call, Store [SELECT] will not appear.

```
Phonebook :100
Search [A-Z/↑/↓]
Store [SELECT]
```

- 2) Press  $\Delta$  /vol/ ,  $\Delta$  /vol/ , or the number keypad to scroll through the phonebook locations. Phonebook locations appear in alphabetical order (from first to last when you press  $\Delta$  /vol/ , from last to first when you press  $\Delta$  /vol/ ).

You can also use letters on the number keys to select the first letter of the desired name. Press a number key (2-9 and 0) once for the first letter, press twice for the second letter, and so on. The first location that begins with the letter you entered appears.

For example, to search for "Movies," press 6 once. Press  $\Delta$  /vol/  or  $\Delta$  /vol/ , until the phonebook location is displayed.

- 3) To finish the viewing operation, press  (or  **phonebook** during a call).



During a call, don't press  or the call will be disconnected.

## MAKING CALLS USING THE PHONEBOOK

### From Standby Mode

- 1) When the phone is in standby mode, view the phonebook location to dial (see “Viewing the Phonebook” on page 30).
- 2) Press **(talk)/flash** or **(speaker)**. The displayed number is dialed.
- 3) To hang up press **(end)**.

```
Movies
0295979035
↓Beethoven9/SPD1
```





### From Talk Mode

- 1) Press **(talk)/flash** or **(speaker)**.
- 2) View the phonebook location to dial (see “Viewing the Phonebook” on page 30).
- 3) Press **(select)/[envelope]**. The number in the displayed phonebook location is dialed.
- 4) To hang up press **(end)**.

## SPEED DIALING





If you store a phone number in a speed dial memory location (10 locations:SPD1 - SPD0), you can use the speed dialing feature. When the phone is in standby mode, press and hold a number key (**(0)-(9)**) associated with the speed dial until the phone number appears, then press **(talk)/flash** or **(speaker)**. The number stored in speed dial (SPD1 - SPD0) is dialed.

## EDITING OR ERASING A STORED NAME, PHONE NUMBER, DISTINCTIVE RING, AND SPEED DIAL

- 1) When the phone is in standby mode, press  **phonebook**.
- 2) Press  /vol/ or  /vol/, or the number keypad to view the phonebook locations (see “Viewing the Phonebook” on page 30).







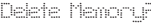

```
Phonebook :100
Search [A-Z/↑/↓]
Store [SELECT]
```

### a. Editing the Stored Data

- 1) When the phonebook location to be edited appears, press  /. Store/Edit Name appears.
- 2) Follow the steps 3 to 7 under “Storing Phone Numbers, Names, Distinctive Rings, and Speed Dial” on page 26-27 to complete the editing operation.
- 3) Press  /. You will hear a confirmation tone.

```
Store/Edit Name
Movies
```

### b. Deleting the Stored Data

- 1) When the phonebook location to be deleted appears, press  /del.  
 appears.
- 2) Press  /vol/ or  /vol/ to move the pointer to Yes.
- 3) Press  /. You hear a confirmation tone.  
 appears in the display.

```
Delete Memory?
Yes
▶ No
```

## CHAIN DIALING

The memory locations in the handset are not limited to phone numbers. You can also store a group of numbers (up to 20 digits), that you need to enter once your call connects. This is referred to as Chain Dialing.

An example of this is a bank account number. Store the account or special number in one of the phonebook locations. (Refer to “Storing Phone Numbers, Names, Distinctive Rings and Speed Dial” on page 26.) When you call your bank and you are prompted to enter the account number, scroll through your phonebook locations until you find your account number, and then press **(select)**/ .



- If you answer a call before the Caller ID message is received (for example, before the second ring), the Caller ID message will not appear.
- When the call is received via a telephone company that does not offer Caller ID service, the caller's phone number and name does not appear. (This includes some international calls.)
- When the call is via a private branch exchange (PBX), the caller's phone number and name may not appear.

## CALLER ID

**You must subscribe to Caller ID services through your local telephone provider to use these features.**

When the telephone rings, the Caller ID feature allows you to view the caller's name, and phone number along with the date and time of call. Additionally, you can dial a number stored in the Caller ID list or save data to your Phonebook locations.

### **Important:**

Memory locations for Caller ID messages and Phonebook locations (including Speed Dials) are common, you can store up to 100 in total. A Caller ID message is not stored when you have stored 100 of the phonebook locations. The earliest Caller ID message is overwritten when you have stored 100 of the phonebook locations and Caller ID messages in total.

The date and time received	21/12 11:20AM
Caller's name	Jane Smith
Caller's phone number	0295979035

- 1) When the Caller ID message is received, the display shows the caller's phone number along with the date and time. The incoming call information is stored in the Caller ID record. If the Caller ID service includes the caller's name, the name will appear in the display (up to 15 characters).

You may receive any one of the following messages:

When a private name is received Private

When an unknown name is received Unavailable

When an overseas call (0000) is received (New Zealand only) OVERSEAS CALL

When invalid data is received Incomplete Data

- 2) When you pick up the phone, the display changes to **Talk**.  
(AutoTalk feature is set to on).



Data errors appear as "■".

## VIEWING THE CALLER ID LIST

The Caller ID list stores information for incoming calls - even unanswered calls. You can store 100 of the Caller ID messages and Phonebook locations (including SpeedDials) in total. You can view the Caller ID list during a call or when the phone is in standby mode.

- 1) Press **call id** .

The summary screen appears. The screen shows the number of new messages and total messages.

- 2) To view the Caller ID messages in historical order (from new to old or from old to new), repeatedly press **▲/vol/▼** to scroll through the messages from the latest to the earliest, or **▲/vol/▲** to scroll back through the messages.

To view the Caller ID messages with alphabetical search, press the number key pad (**2-9** and **0**) with the letter associated with the first letter of the desired message.



Once you view the Caller ID list with alphabetical search, you cannot switch back to historical order (from new to old or from old to new) unless you exit and re-enter the operation.

- 3) To finish the viewing operation, press **end** (or **call id** during a call).



- The number of calls from the same Caller ID appears next to the received time. Once you view the new message, the number will be cleared and disappear.
- During a call, don't press **end** or the call will be disconnected.



- Once the Caller ID data has been deleted, the information cannot be retrieved.
- **Standby Mode** - The handset is not in use and **(talk)/flash** has not been pressed.
- **Talk Mode** - The handset is not in the cradle and **(talk)/flash** or **(speaker)** has been pressed enabling a dial tone. **Talk** appears on the display.

## DELETING A CALLER ID MESSAGE

### Deleting Information from the Caller ID List

- 1) When the phone is in standby mode, view the Caller ID information to be deleted (see “Viewing the Caller ID List” on page 35).
- 2) Press **(menu) /del**. **Delete Caller ID** appears.
- 3) Press **▲ /vol/▲** or **▲ /vol/▼** to choose **Yes**.
- 4) Press **(select) /✉**. You will hear a confirmation tone.

```
Delete Caller ID
▶Yes
  No
```

### Deleting all Caller ID names/numbers

- 1) When the phone is in standby mode, press call id.
- 2) Press **(menu) /del**. **Delete All?** appears.
- 3) Press **▲ /vol/▲** or **▲ /vol/▼** to choose **Yes**.
- 4) Press **(select) /✉**. You will hear a confirmation tone.

```
Caller ID
New : 5
Total: 25
```

```
Delete All?
  Yes
▶No
```



## USING THE CALLER ID MESSAGE LIST

### Calling a party from the Caller ID list

#### From Standby mode

- 1) When the phone is in standby mode, view the Caller ID message (see “Viewing the Caller ID List” on page 35).
- 2) Press **(talk)/flash** or **(M) speaker**. The displayed phone number dials automatically.

```
21/12 11:20AM  
Jane Smith  
0295979035
```

#### From Talk mode

- 1) Press **(talk)/flash** or **(M) speaker**.
- 2) View the Caller ID message you want to dial (see “Viewing the Caller ID List” on page 35).
- 3) Press **(select)/☐**. The displayed phone number will be dialed.

#### Adding Zero to Caller ID message (New Zealand only)

While you review Caller ID information while the Insert Zero option is set to On, “0” is inserted. Refer to page 15 “Setting Insert Zero (New Zealand only)” to set the Insert Zero option to On or Off. New Zealand Telecom customers should leave Insert Zero to On. Other New Zealand companies may require Insert Zero set to Off.

#### Storing Caller ID messages in the Phonebook

Messages shown in the Caller ID list can be stored in the phonebook. The phone number and name of the party on the Caller ID list can be stored in memory.

- 1) When the phone is in standby mode, view the Caller ID message to be stored.  
Then press **(select)/☐**. *Store/Edit Name* appears.
- 2) To complete the setting, follow the steps 4-8 in “Storing Phone Numbers, Names, Distinctive Rings, and Speed dial” on page 26-27.



- You cannot make a call from the Caller ID list if your phone is connected to a private branch exchange (PBX).
- If a call comes in via a telephone system that does not offer Caller ID service, no information is stored.
- If the Caller ID message was received as a private/unknown number, or the message does not have the number, you cannot store the message in the Phonebook. If it was received as private/unknown name, the message will be stored as <No Name>.
- Even if the 100 memory locations are full, the message will be stored in the Phonebook. However, the message will be erased from the Caller ID list.



**NOTE**

- To use the WDECT3305, register it to the original base.
- Save this manual for detailed operation.
- All of the handsets ring when a call is received.

## EXPANDING YOUR PHONE

### 4 Multi-Handset Expendability

Your phone supports up to 4 handsets (including the handset(s) supplied with your phone). You can now place a fully-featured cordless handset anywhere AC power is available to connect the handset charger.

Up to 2 handsets can be used for an outside and/or intercom call.

For example, the phone permits 3-way conferencing (2 handsets and an outside line).

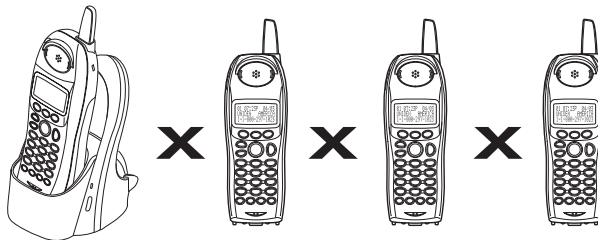

#### IMPORTANT:

- If you purchase a WDECT3305 extra handset, please register the handset to the WDECT3315 series base before use. The WDECT3305 will not operate until it is registered.
- If you change a setting of the Global Setup menu in one of the handsets, you change settings for all the handsets. For all other features they must be set separately through each handset.

## REGISTER THE HANDSET

If you purchase an extra handset, you need to register the handset to the base before use. Only one handset can be registered at a time.

The handset ID for the supplied handset(s) was assigned at the factory, which has #1 or #2 in the display (#2 for models that have two handsets in packaging). When you register additional handset to the base, the handset ID will be assigned.

- 1) Before registering the extra handset, the battery pack must be charged for 15-20 hours.
- 2) Place the extra handset in the main base unit to begin registration.
- 3) While the handset is registering, `Handset Registering` will appear in the LCD.

When `Registration Complete` is displayed, the handset has been registered to the base.

If `Registration Failed` appears, please try these steps again.

Place handset  
on main base  
to register

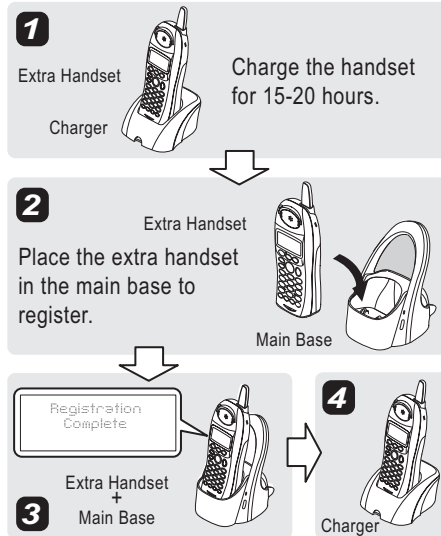

- An extra handset can be registered when the main base is in standby mode.
- **Standby Mode** - The handset is not in use and `(talk)/flash` has not been pressed.



- Two handsets can be in Direct Link mode while other handsets are in use.
- Direct Link will not work in speaker mode.



The Room/Baby monitor function is not a replacement for regularly checking the safety and security of children. The operating time is limited to the remaining charge of the battery and is not suitable for continuous overnight use.

## USING TWO WAY COMMUNICATION BETWEEN THE HANDSETS ANYWHERE WITHOUT THE BASE (DIRECTLINK)

To use this feature, you must enter the two handsets into the DirectLink mode first.

To enter the DirectLink mode - See page 11

### DirectLink Call

- 1) When the phone is in the DirectLink standby mode, press **(talk)/flash** (example of DirectLink from handset #1).
- 2) Select the handset to which you wish to DirectLink with by pressing the number keys **(1-4)**. Your handset will then page the other handset.
- 3) On the receiving handset, press **(talk)/flash**, or if Any Key Answer is on, press any number key, **(\*/tone/←)**, or **(#/→)**.
- 4) When you finish your conversation, press **(end)** on either handset. Return the handset to the **cradle**, or press **(menu)** / **del**, and then **(select)/☑** to return to normal standby mode (canceling DirectLink mode).

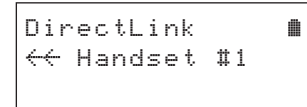
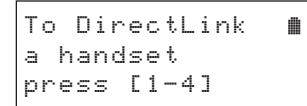
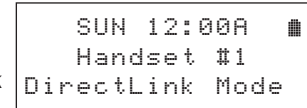
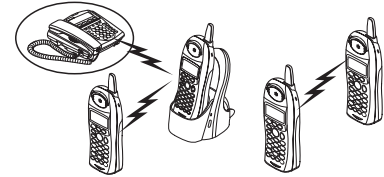

## ROOM MONITOR

This feature allows you to monitor sounds in another room. To use this feature, place the handset in the desired room to monitor (act as a remote mic), and place the other near the listener (remote speaker). For instruction, see "Using the Room Monitor" on page 12.



## 3-WAY CONFERENCING

The phone permits 3-way conversations between 2 handsets, and an outside line.

- 1) During a call, press **(talk)/flash** on another handset to initiate the 3-way conversation.
- 2) To remove either caller from your conversation, press **(end)** key on either handset.

The other handset will still be connected to the call.

## INTERCOM/CALL TRANSFER FEATURE

If you have one or more extra handsets, you can enjoy an intercom call between handsets. Also, you can place an outside call on hold and transfer the call to another handset.

### Intercom

- 1) Press **(hold) /transfer/int'com** in standby mode.
- 2) Select the handset you want to talk with from the selection list within 30 seconds. To select the handset, press **△/vol/△** or **△/vol/▽** and then press **(select)/✉**.

If you select All, all handsets will be paged. An intercom tone sounds.

- 3) On the receiving handset, to answer the call, press **(talk)/flash** or **(hold) /transfer/int'com**. If you turn AutoTalk on, pick up the handset from the cradle. If Anykey Answer is on, press any number key, **(\*)/tone/←**, or **(#)/→**.
- 4) To finish the intercom call, press **(end)** on either handset.

To intercom	
▶Handset	#2
Handset	#3



- If the party is busy or out of range, the handset returns to standby mode.
- If any of the following occurs while selecting the other handset, the operation will be canceled.

- Press **(talk)/flash** or **(🔊)** **speaker**.

- Receive an outside/intercom call or page.

- When the party does not answer within one minute, the operation is canceled.

• **Standby Mode** - The handset is not in use and **(talk)/flash** has not been pressed.

## Call Transfer Feature

- 1) During a call, press **(hold)** /**transfer/int'com**.
- 2) Select a handset to transfer the call within 10 seconds. (Refer to step 2 in the intercom section on page 41).

The call will automatically be placed on hold, and an intercom tone sounds.

To cancel the transfer, press **(talk)/flash** or **(M)** **speaker** on the initiating handset.

Hold, to transfer	
▶ Handset	#2
Handset	#3

- 3) On the receiving handset, to answer the page, press **(talk)/flash** or **(hold)** / **transfer/int'com**. If you turn AutoTalk on, pick up the handset from the cradle. If Anykey Answer is On, press any number key, **(X)/tone/←** , or **(#)/→** . The intercom mode is activated, but the caller is still on hold.
- 4) To transfer the call, press **(end)** on the initiating handset, and press **(talk)/flash** on the receiving handset.

## REPLACING THE BASE

If the base unit is replaced with a different base from this same series of cordless models, you must clear handset (s) and base identification numbers. To do this, select "System Reset" from handsets display menu option list (see page 17 for guidance).



For model number verification, visit our website [www.uniden.com.au](http://www.uniden.com.au) or [www.uniden.co.nz](http://www.uniden.co.nz)

## CHANGING THE DIGITAL SECURITY CODE

The digital security code is an identification code used to connect the handset and the base unit. Normally, setting the code is not necessary. In the rare situation that you suspect another cordless telephone is using the same security code, you can change the code.

To change the digital security code:

**1. Perform the “System Reset” menu options (“De-register the Handset” and “Replacing the Base Setting”) for all the handsets you have (see page 17).**

**2. To register all the handsets do the following steps:**

- 1) Place a handset, one at a time in the base.
- 2) Registration starts automatically.

While registering *Handset Registering* appears in the display.

- 3) When the registration is complete, *Registration Complete* appears in the display.
- 4) Repeat steps 1 - 3 for another handsets.

If the registration fails, *Registration Failed* appears in the display. Try the steps above again.

## **NOTE ON POWER SOURCES**

### **Battery replacement and handling**

When the operating time becomes short, even after a battery is recharged, please replace the battery. With normal usage, your battery should last about one year. Please contact your place of purchase or the Uniden Parts Department for a replacement battery.

### **Warning**

To avoid the risk of personal injury or property damage from fire or electrical shock, only use the Uniden battery model and Uniden adapter model specifically designated for this product.

### **Caution**

- Use only the specified Uniden battery pack (BT-446).
- Do not remove the batteries from the handset to charge them.
- Never throw the battery into a fire, disassemble them, or heat them.
- Do not remove or damage the battery casing.



## TROUBLESHOOTING

If your phone is not performing to your expectations, please try these simple steps first.

Symptom	Suggestion
<b>The charge LED won't illuminate when the handset is placed in the cradle.</b>	<ul style="list-style-type: none"><li>• Make sure the AC adapter is plugged into the base and wall outlet.</li><li>• Make sure the handset is properly seated in the cradle.</li><li>• Make sure the charging contacts on the handset cradle are clean.</li></ul>
<b>The audio sounds weak and/or scratchy.</b>	<ul style="list-style-type: none"><li>• Move the handset and/or base to a different location away from metal objects or appliances and try again.</li><li>• Make sure that you are not too far from the base.</li></ul>
<b>Can't make or receive calls.</b>	<ul style="list-style-type: none"><li>• Check both ends of the base telephone cord.</li><li>• Make sure the AC adapter is plugged into the base and wall outlet.</li><li>• Disconnect the AC adapter for a few minutes, then reconnect it.</li><li>• Remove the base ID (see "Replacing the Base Setting" on page 17) and register the handset (see "Register the Handset" on page 39).</li><li>• Make sure that you are not too far from the base.</li><li>• If an outside call is already established, you may not be able to make another outside call.</li></ul>
<b>The handset doesn't ring or receive a page.</b>	<ul style="list-style-type: none"><li>• Charge the batteries in the handset for 15-20 hours by placing the handset on the base or charging cradle.</li><li>• The handset may be too far away from the base unit.</li><li>• Place the base unit away from appliances or metal objects.</li><li>• Remove the base ID (see "Replacing the Base Setting" on page 17) and register the handset (see "Register the Handset" on page 39).</li></ul>
<b>"Unavailable" appears in the display.</b>	<ul style="list-style-type: none"><li>• Make sure that another handset not too far from the base.</li></ul>

Symptom	Suggestion
<b>Severe noise interference.</b>	<ul style="list-style-type: none"> <li>• Keep the handset away from microwave ovens, computers, remote control toys, wireless microphones, alarm systems, intercoms, room monitors, fluorescent lights, and electrical appliances.</li> <li>• Move to another location or turn off the source of interference.</li> </ul>
<b>The Caller ID does not display.</b>	<ul style="list-style-type: none"> <li>• The handset was picked up before the second ring.</li> <li>• The call was placed through a switchboard.</li> <li>• Call your local telephone company to verify your Caller ID service is current.</li> </ul>
<b>Voice Message Indication does not work.</b>	<ul style="list-style-type: none"> <li>• Contact your local telephone company to make sure that your telephone receives FSK message signaling.</li> </ul>
<b>You cannot register the handset at the base.</b>	<ul style="list-style-type: none"> <li>• Please make sure your batteries are charged for 15-20 hours. (see "Register the Handset" on page 39).</li> <li>• Remove the base ID (see "Replacing the Base Setting" on page 17) and register the handset (see "Register the Handset" on page 39).</li> </ul>
<b>The handset doesn't communicate with the other handsets.</b>	<ul style="list-style-type: none"> <li>• Remove the base ID (see "Replacing the Base Setting" on page 17) and register the handset (see "Register the Handset" on page 39).</li> <li>• Make sure that you have registered all handsets.</li> </ul>
<b>An extra handset can't join the conversation.</b>	<ul style="list-style-type: none"> <li>• Make sure there are not 2 handsets already using the 3-way conference feature.</li> </ul>
<b>You cannot make an intercom call with other handset.</b>	<ul style="list-style-type: none"> <li>• Make sure that the receiving handset is not in use.</li> </ul>
<b>If you still have a problem.</b>	<ul style="list-style-type: none"> <li>• Check our web site for the latest information and frequently asked questions.  <a href="http://www.uniden.com.au">www.uniden.com.au</a>  <a href="http://www.uniden.co.nz">www.uniden.co.nz</a> </li> </ul>

## INDEX

### 0 - 9

- 3-way conferencing..... 41
- 20 ring options..... 13

### A

- Anykey answer..... 14
- AutoTalk..... 13

### B

- Banner ..... 14
- Battery
  - Replacement and handling..... 44
- Beltclip..... 6
- Booster ..... 23

### C

- Caller ID
  - Caller ID service..... 34
  - Calling ..... 37
  - Call Waiting..... 24
  - Deleting ..... 36
  - Storing ..... 37
  - Using ..... 37
  - Viewing ..... 35
- Call transfer feature ..... 42
- Chain dialing..... 33
- Clock..... 15
- Copy Phonebook ..... 16

### D

- Day & Time ..... 15
- Deregister the handset..... 17
- Dial Mode..... 16
- Digital security code ..... 43
- DirectLink mode..... 11
- Distinctive ringer ..... 13

### E, F, G, H

- Earpiece volume ..... 21
- Expanding your phone..... 38
- Global setup..... 15
- Handset setup..... 9
- Hands-free conversation..... 18
- Headset installation ..... 7

### I, J, K, L

- Intercom..... 41
- Insert Zero ..... 15
- Key touch tone..... 14
- Keypad lock..... 19

### M, N, O

- Making a call..... 18
- Mute..... 22
- Name Tag ..... 15
- Overseas call ..... 34

### P, Q

- Phonebook ..... 26
  - Editing ..... 32
  - Erasing ..... 32
  - Making calls..... 31
  - Storing ..... 26
  - Viewing ..... 30

### R

- Receiving a call..... 18
- Redialing a call ..... 20
- Register the handset..... 39
- Replacing the base..... 42
- Ringer volume..... 21

### S

- Setting up
  - Extra handset..... 39
  - Handset ..... 12
- Speed dialing..... 31
- System reset..... 17

### T, U, V, W, X, Y, Z

- Transferring a call ..... 41
- Troubleshooting..... 45
- Voice Mail ..... 25
  - Programming ..... 12
- Warranty ..... 48

## WARRANTY

### One Year Limited Warranty

#### UNIDEN WDECT3315 / WDECT 3315+1 CORDLESS PHONE

**Important:** Evidence of original purchase is required for warranty service.

**Warrantor:** Uniden Australia Pty Limited A.B.N. 58 001 865 498

Uniden New Zealand Limited

Warranty only available in original country of purchase.

**ELEMENT OF WARRANTY:** Uniden warrants to the original retail owner for the duration of this warranty, its WDECT3315 or WDECT3315 +1 cordless phone (herein after referred to as the Product), to be free from defects in materials and craftsmanship with only the limitations or exclusions set out below. Warranty is only valid in the original country of purchase.

#### WARRANTY DURATION:

This warranty to the original retail owner only, shall terminate and be of no further effect ONE (1) year after the date of original retail sale. This warranty will be deemed invalid if the Product is;

- (A) Damaged or not maintained as reasonable and necessary,
- (B) Modified, altered or used as part of any conversion kits, subassemblies, or any configurations not sold by Uniden,
- (C) Improperly installed,
- (D) Repaired by someone other than an authorized Uniden Repair Agent for a defect or malfunction covered by this warranty,
- (E) Used in conjunction with any equipment or parts or as part of a system not manufactured by Uniden, or
- (F) Where the Serial Number label of the product has been removed or damaged beyond recognition.

Warranty only valid in the country of original retail/sale.

#### PARTS COVERED:

This warranty covers for one (1) year, the Product and included accessories.

#### STATEMENT OF REMEDY:

In the event that the Product does not conform to this warranty at any time while this warranty is in effect, the warrantor at its discretion, will repair the defect or replace the Product and return it to you without charge for parts or service. This warranty does not provide for reimbursement or payment of incidental or consequential damages.

This EXPRESS WARRANTY is in addition to and does not in any way affect your rights under the TRADE PRACTICES ACT 1974 (Cth) (Australia) or the CONSUMER GUARANTEES ACT (New Zealand).

**PROCEDURE FOR OBTAINING PERFORMANCE OR WARRANTY:** In the event that the Product does not conform to this warranty, the Product should be shipped or delivered, freight pre-paid, with evidence of original purchase (eg. a copy of the sales docket), to the warrantor at:

#### UNIDEN AUSTRALIA PTY LIMITED SERVICE DIVISION

345 Princes Highway, Rockdale NSW 2216

Fx (02) 9599 3278

[www.uniden.com.au](http://www.uniden.com.au)

#### UNIDEN NEW ZEALAND LIMITED SERVICE DIVISION

150 Harris Road, East Tamaki, Auckland

Fx (09) 274 4253

[www.uniden.co.nz](http://www.uniden.co.nz)

Customers in other States should ship or deliver the Product freight pre-paid to their nearest Uniden Authorized Repair Centre (Contact Uniden for the nearest Warranty Agent to you).

## NOTES

## NOTES





**Uniden®**

©2007 Uniden Australia Pty Limited/Uniden New Zealand Limited  
Part Code UPZZ01457BZ(0) Printed in China